

SAVIN

9220/9220DL

Operating Instructions

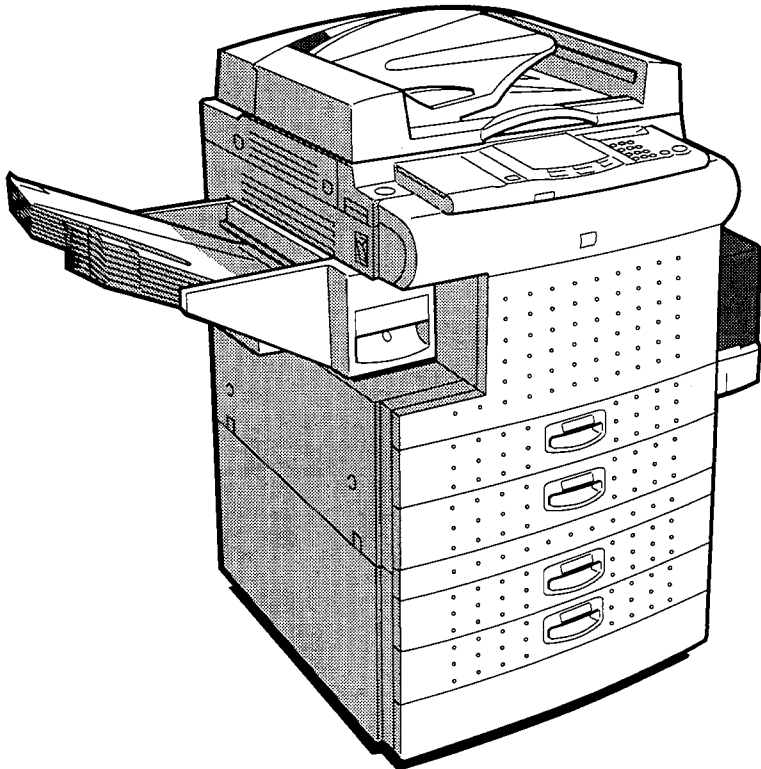

Notes: The model names of the machines do not appear in the following pages. Check the type of your machine before reading this manual. (For details, see page 2.)

Basic : 9220

**With 1000-sheet large capacity tray
and unit for two-sided copying** : 9220DL

Certain types may not be available in some countries. For details, please contact your local dealer.

For good copy quality, Savin recommends that you use genuine Savin toner.

Savin shall not be responsible for any damage or expense that may result from the use of parts other than genuine Savin parts in your Savin office product.

Note: Some illustrations may be slightly different from your machine.

Note: Certain options may not be available in some countries. For details, please contact your local dealer.

Power Source: 120 V, 60 Hz, more than 12A
Please make sure to connect the power cord to a power source as above.
For details about power source, see page 140.

INTRODUCTION

This manual contains detailed instructions on the operation and maintenance of this copier. To get maximum versatility from this copier, all operators should carefully read and follow the instructions in this manual. Please keep this manual in a handy place near the machine.

Please read the next section before using this copier. It contains important information related to USER SAFETY and PREVENTING EQUIPMENT PROBLEMS.

SAFETY INFORMATION

When using your copier, the following safety precautions should always be followed.

Safety During Operation

In this manual, all safety messages are identified by the words "WARNING" and "CAUTION". These words mean the following:

WARNING: Important information to alert you to a situation that might cause serious injury and damage to your property if instructions are not followed.

CAUTION: Important information that tells how to prevent damage to equipment, or how to avoid a situation that might cause minor injury.

WARNINGS:

Since some parts of the copier are supplied with high electrical voltage, touch only the parts specified in this manual.

Do not modify or replace any parts other than the ones specified in this manual.

Do not incinerate toner or toner containers. Toner dust might ignite when exposed to open flames.

Do not store toner where it will be exposed to heat.

Do not eat or swallow toner, and keep it out of reach of children.

The fusing section can be very hot. Be careful when handling it.

CAUTIONS:

While copying, do not turn off the main switch.

While copying, do not open the front cover.

While copying, do not lift the platen cover, or the optional document feeder.

While copying, do not unplug the power cord.

Do not lay anything weighing more than 22 lb on the exposure glass.

Do not place tools or other hard objects on the exposure glass.

Keep corrosive liquids, such as acid, off the machine.

Do not allow paper clips, staples, or other small metallic objects to fall inside the machine.

General Safety Information

- Always turn the copier off when you have finished copying for the day, but leave it plugged in.
- When the copier will not be used for a long period, disconnect the power cord.
- If the copier must be transported by vehicle, please contact your service representative.
- When the main switch is in the Stand-by position, the optional anticondensation heaters are on. In case of emergency, unplug the machine's power cord.
- To disconnect the power source, the main plug must be pulled.

TABLE OF CONTENTS

WHERE IS IT & WHAT IS IT

MODELS	2
OPTIONS	3
COPIER EXTERIOR AND INTERIOR	4
PAPER TRAYS	6
OPERATION PANEL	8
Keys 1 Basic	8
Indicators 1 Basic	10
Keys 2 With 1000-sheet Large Capacity Tray And Unit For Two-sided Copying.....	12
Indicators 2 With 1000-sheet Large Capacity Tray And Unit For Two-sided Copying.....	14

WHAT YOU CAN DO WITH THIS COPIER

FUNCTIONS	18
HINTS	25
Example 1	25
Example 2	26
Example 3	27

SETTING ORIGINALS

ORIGINALS	30
Recommended Originals	30
Non-recommended Originals For The Optional Document Feeder	30
SETTING ORIGINALS ON THE EXPOSURE GLASS	31
SETTING A STACK OF ORIGINALS IN THE OPTIONAL DOCUMENT FEEDER	32

SETTING ONE ORIGINAL AT A TIME IN THE OPTIONAL DOCUMENT FEEDER.....	34
--	-----------

COPYING

STARTING THE COPIER	38
When The Main Switch Is In The Stand-by Position	38
When the Energy Saver indicator is On	39
When The Copier Is Set For User Codes.....	39
FREQUENTLY USED FUNCTIONS	40
One-to-one Copying	40
Adjusting Copy Image Density	41
Having The Copier Choose The Paper Size (Auto Paper Select).....	42
Having The Copier Choose The Reproduction Ratios (Auto Reduce/Enlarge).....	44
Copying From The Bypass Feed Table	45
Temporarily Stopping One Job To Copy Something Else (Interrupt Copying).....	47
Reducing And Enlarging.....	49
Entering Copy Job Settings During The Warm-up Period (Auto Start)	52
MAKING ONE-SIDED COPIES FROM VARIOUS ORIGINALS (Single Copies)	53
From 2 One-sided Originals To 1 One-sided Copy (Combine Originals)...	53
From 1 Two-sided Original To 2 One-sided Copies (2 Sided Original).....	55
From 2 Facing Pages To 2 One-sided Copies (Book Original).....	56
ADDING OR INSERTING SHEETS (Cover/Slip Sheet)	58
Copying The Front Cover Of The Originals (Copy Cover)	58
Copying The Front And Back Covers Of The Originals.....	59
Adding A Front Cover Sheet (Blank Cover).....	61
Adding Front And Back Cover Sheets	62
Inserting Slip Sheets Between OHP Transparencies (OHP Slip Sheet).....	63
ERASING PARTS OF THE COPY IMAGE (Erase).....	65
Erasing The Center Margin Of The Original Image (Erase Center)	65
Erasing The Surrounding Area Of The Original Image (Erase Border).....	65

Erasing The Center Margin And Surrounding Area Of The Original Image.....	65
STORING YOUR COPY SETTINGS IN MEMORY (Program).....	67
Storing Your Settings	67
Protecting Your Settings From Being Overwritten	68
Recalling Your Settings.....	68
Unprotecting Your Settings	69
MAKING TWO-SIDED COPIES (ONLY WITH MODEL HAVING THIS FEATURE)	70
From An Even Number Of One-Sided Originals (1 Sided Originals, even)	70
From An Odd Number Of One-Sided Originals (1 Sided Originals, odd)	71
From Two-Sided Originals (2 Sided Original)	72
From Facing Pages (Book Original).....	73
FINISHING (OPTION).....	74
Sorting Into Sets (Sort).....	74
Stapling Copies (Staple)	75
Stacking Together All Copies Of A Page (Stack)	78
COPYING WITH USER CODES	80
SAVING ENERGY	81
COMBINATION CHART.....	82
WHAT TO DO IF SOMETHING GOES WRONG	
IF YOUR COPIER DOES NOT OPERATE AS YOU WANT	86
IF YOU CANNOT MAKE COPIES AS YOU WANT	90
 IS LIT: LOADING PAPER	91
Non-recommended Paper For Paper Trays.....	91
Notes For Paper.....	91
Loading Paper In The 250-sheet or 500-sheet Tray	92
Loading Paper In The Large Capacity Tray (only with model having this tray)	93

 IS LIT OR BLINKING: ADDING TONER	94
--	----

 IS LIT: ADDING STAPLES	95
--	----

If Your Copier Is Equipped With The 10-bin Sorter Stapler	95
---	----

 IS LIT: CLEARING MISFEEDS	96
---	----

Check The Misfeed Location Display	96
--	----

When A, B, C, Y, Or Z Is Lit:	97
-------------------------------------	----

When R Is Lit:	98
----------------------	----

When P Is Lit (Original Misfeed):	99
---	----

REMOVING JAMMED STAPLES	100
--------------------------------------	------------

If Your Copier Is Equipped With The 10-bin Sorter Stapler	100
---	-----

CHANGING THE COPIER'S SETTINGS

CHANGING PAPER SIZE	102
----------------------------------	------------

Paper Trays	102
-------------------	-----

Copier's 250-sheet Trays	104
--------------------------------	-----

Optional 500-sheet Or 1000-sheet Paper Tray Unit And Bypass Feed Table	107
---	-----

USER TOOLS	112
-------------------------	------------

How To Access User Tools	112
--------------------------------	-----

How To Change Adjustment Values Or Modes	113
--	-----

User Tool Menu	115
----------------------	-----

SERVICE REPRESENTATIVE SETTING	131
---	------------

**MAINTAINING YOUR COPIER
DO'S AND DON'TS
WHERE TO PUT YOUR COPIER
REMARKS
USE AND STORAGE OF SUPPLIES**

MAINTAINING YOUR COPIER	136
--------------------------------------	------------

DO'S AND DON'TS..... 138

WHERE TO PUT YOUR COPIER..... 139

REMARKS 141

USE AND STORAGE OF SUPPLIES..... 143

SPECIFICATIONS

COPIER 146

DOCUMENT FEEDER (OPTION) 149

10-BIN SORTER STAPLER (OPTION) 150

20-BIN SORTER (OPTION) 151

10-BIN SORTER (OPTION) 151

500-SHEET TRAY UNIT (OPTION) 152

1000-SHEET TRAY UNIT (OPTION) 152

WHERE IS IT & WHAT IS IT

WHERE IS IT & WHAT IS IT

Basic

Two 250-sheet trays

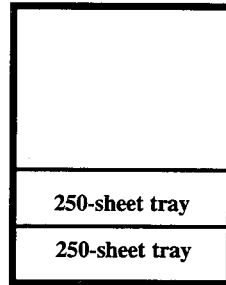

With 1000-sheet large capacity tray and unit for two-sided copying

- A 250-sheet tray
- A 1000-sheet large capacity tray
- A unit for two-sided copying

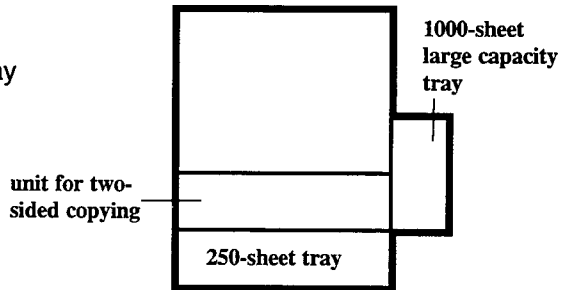

OPTIONS

This copier can be provided with the following options:

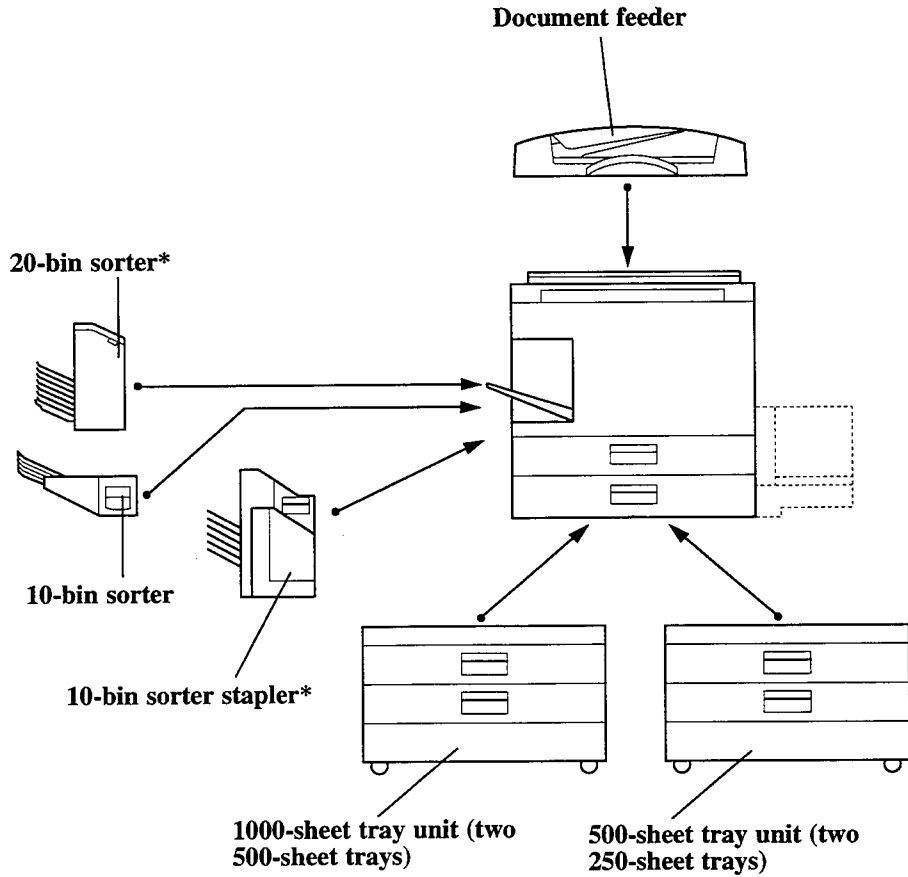

Other options: Platen cover, key counter

*These options require the optional sorter adapter.

COPIER EXTERIOR AND INTERIOR

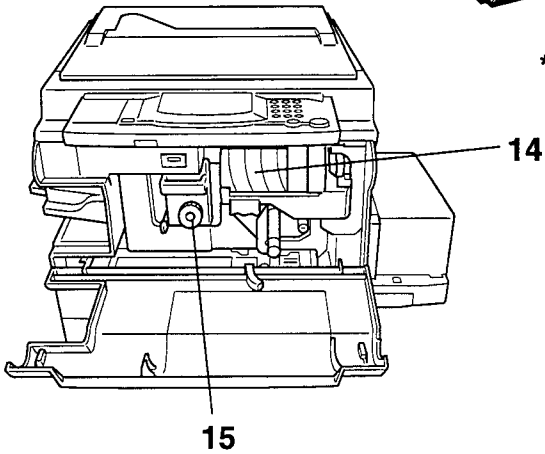
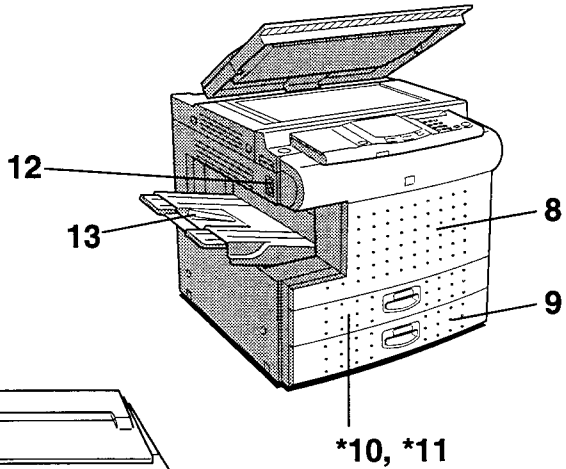
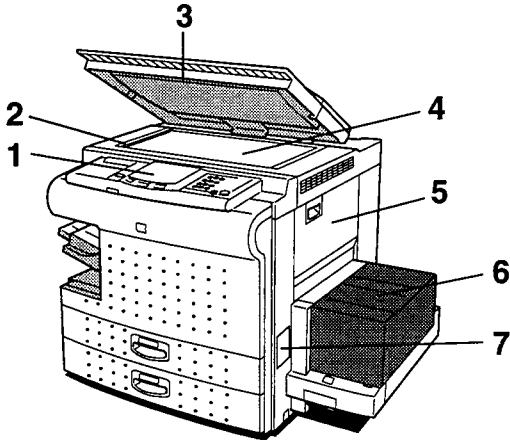

- | | |
|--|---|
| 1. Operation panel | Operator controls and indicators are located here. |
| 2. Left scale | Use to align originals on the exposure glass. |
| 3. Platen cover (option) | Lower this cover over originals for copying. |
| 4. Exposure glass | Position originals here face down for copying. |
| 5. Bypass feed table | Use to copy onto OHP sheets, adhesive labels, translucent paper, and post cards. |
| 6. 1000-sheet large capacity tray | This tray can hold 1,000 sheets of copy paper. One of two models have this tray. (☛ See page 2.) |
| 7. Key counter holder | Insert the optional key counter here. |
| 8. Front cover | Open to access the inside of the copier. |
| 9. 250-sheet tray | This tray can hold 250 sheets of copy paper. |
| *10. 250-sheet tray | This tray can hold 250 sheets of copy paper. The model with a unit for two-sided copying does not have this tray. Instead, it has the unit for two-sided copying (*11). |
| *11. Unit for two-sided copying | This unit is used to make two-sided copies. |
| 12. Main switch | Switches the copier between on and stand-by conditions. ("stand-by" means that the anticondensation heaters are on.) |
| 13. Copy tray | Completed copies are delivered here. |
| 14. Toner Bottle | Replace the toner bottle when the  Add Toner indicator is lit or blinking. |
| 15. Fusing Unit | Fuses the copy image to the paper. When accessing the inside of the copier, use caution. This unit may be very hot. |

PAPER TRAYS

Each 250-sheet or 500-sheet tray's name changes depending on what kind of copier and optional paper tray unit you have. Find your copier among the illustrations below and on the next page. Then, when you find paper tray's name (ex. 1st tray) in this manual, confirm which paper tray is pointed in the case of your copier.

Basic

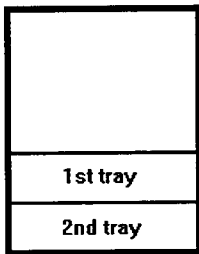

With optional 500-sheet tray unit

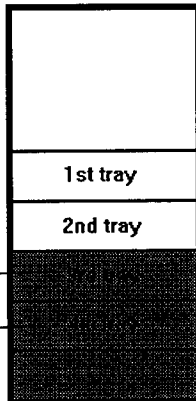

250 sheets
for each
tray

With optional 1000-sheet tray unit

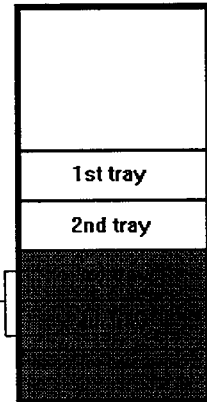

500 sheets
for each
tray

With large capacity tray and unit for two-sided copying

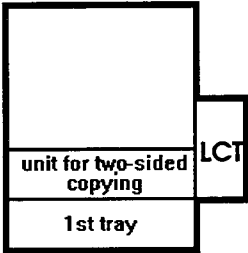

With large capacity tray, unit for two-sided copying, and optional 500-sheet tray unit

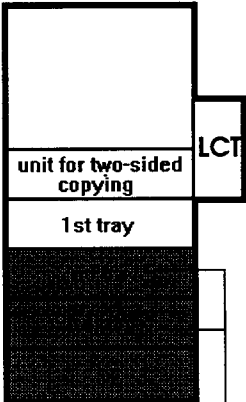

250 sheets for each tray

With large capacity tray, unit for two-sided copying, and optional 1000-sheet tray unit

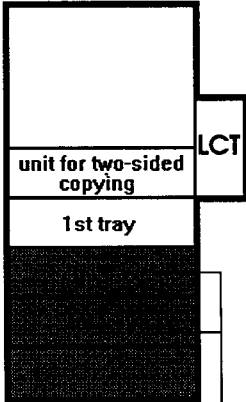

500 sheets for each tray

WHERE IS IT & WHAT IS IT

OPERATION PANEL

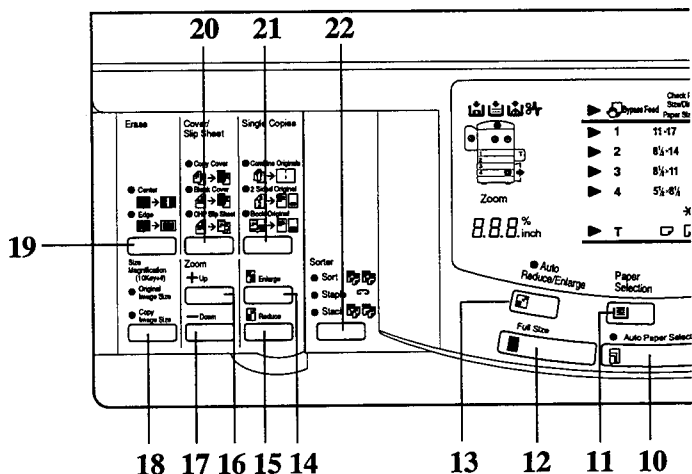
Keys 1
Basic

1. **Program key** See page 67.
2. **Clear Modes/Energy Saver key**
Press to clear the copier of previously entered settings. Press this key for more than 1 second to enter/exit the Energy Saver mode. See pages 39 and 81.
3. **Interrupt key** See pages 47 and 48.
4. **Recall/Enter key**
Use to enter data.
5. **Start key**
Press to start copying.
Use to set the Auto Start.
 See page 52.
6. **Clear/Stop key**
Press to cancel the copy number entered. While copying, press to stop copying. This key is also used to clear data.
7. **Number keys**
Use to enter the desired number of copies. They are also used to enter data.
8. **Lighter and Darker keys**
 See page 41.
9. **Auto Image Density key**
 See page 41.
10. **Auto Paper Select key**
 See page 42.

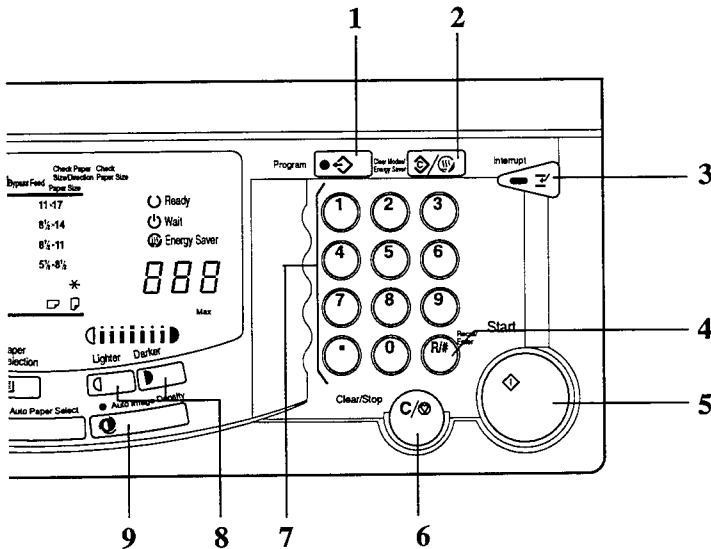

- | | |
|--|---|
| <p>11. Paper Selection key
 See page 40.</p> <p>12. Full Size key See page 40.</p> <p>13. Auto Reduce/Enlarge key
 See page 44.</p> <p>14. Enlarge key See page 49.</p> <p>15. Reduce key See page 49.</p> <p>16. Zoom Up key
 Enlarges in 1% steps. See page 50.</p> <p>17. Zoom Down key
 Reduces in 1% steps. See page 50.</p> | <p>18. Size Magnification key
 Copier sets the magnification for your paper and original sizes. See page 51.</p> <p>19. Erase key See page 65.</p> <p>20. Cover/Slip Sheet key
 See pages 58 ~ 64.</p> <p>21. Single Copies key
 See pages 53 ~ 57.</p> <p>22. Sorter key (option)
 See pages 74 ~ 79.</p> |
|--|---|

Indicators 1 Basic

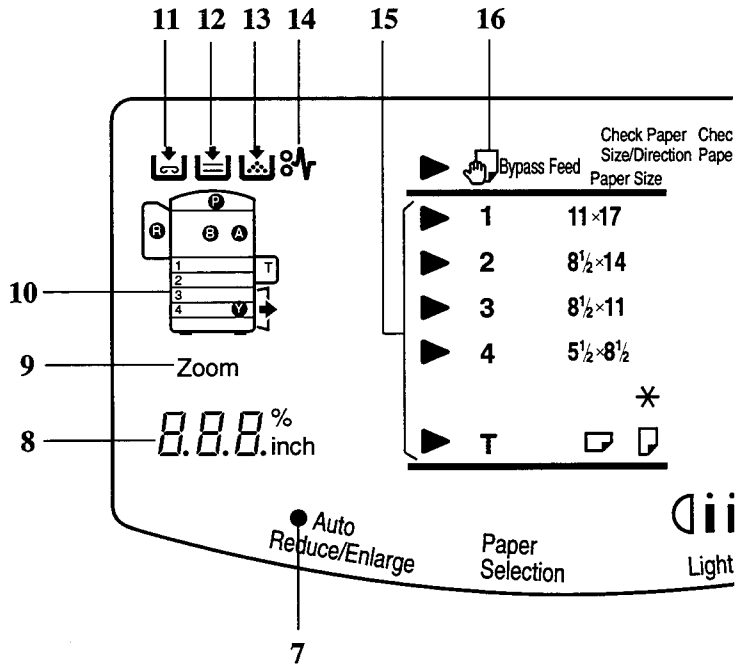

1. **Ready indicator** ☛ See page 38.
2. **Wait indicator** ☛ See page 38.
3. **Energy Saver indicator**
☛ See pages 39 and 81.
4. **Copy Counter**
Indicates the number of copies.
Data display. ☛ See pages 87 and 112.
5. **Max indicator** ☛ See page 89.
6. **Manual Image Density indicator**
☛ See pages 41 and 89.
7. **Auto Reduce/Enlarge indicator**
☛ See page 44.
8. **Three Digit indicator**
Data display.
9. **Zoom indicator**
Lights when you use the Zoom function.

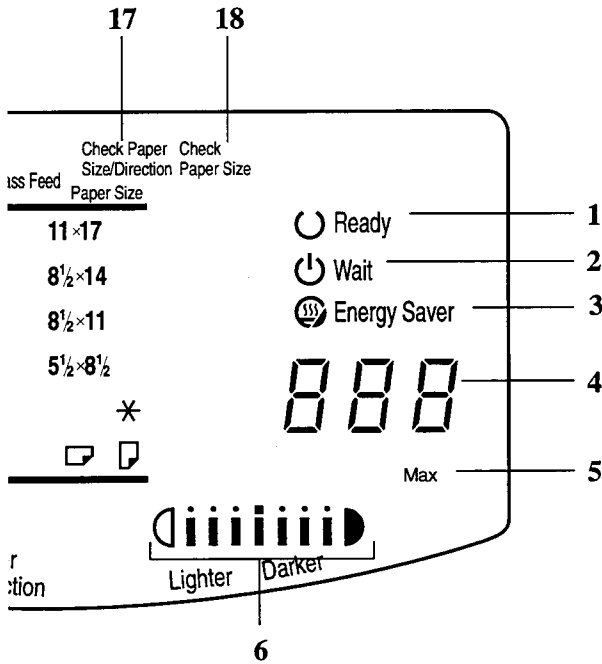

10. **Misfeed Location display**
 See page 96.
11. **Add Staple indicator** See pages 86 and 95.
12. **Load Paper indicator**
 See pages 86 and 91.
13. **Add Toner indicator** See pages 86 and 94.
14. **Check Paper Path indicator**
 See pages 86 and 96.
15. **Paper Size indicators**
 Show the selected feed station, copy paper size, and direction.
16. **Bypass Feed indicator**
 See page 46.
17. **Check Paper Size/Direction indicator**
 See page 89.
18. **Check Paper Size indicator**
 See page 88.

Keys 2

With 1000-sheet Large Capacity Tray And Unit For Two-sided Copying

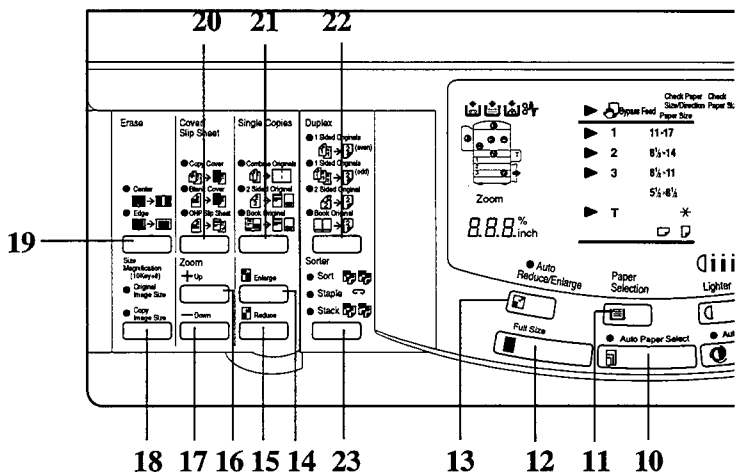

1. **Program key** See page 67.
2. **Clear Modes/Energy Saver key**
Press to clear the copier of previously entered settings. Press this key for more than 1 second to enter/exit the Energy Saver mode. See pages 39 and 81.
3. **Interrupt key** See pages 47 and 48.
4. **Recall/Enter key**
Use to enter data in selected mode.
5. **Start key**
Press to start copying.
Use to set the Auto Start. See page 52.
6. **Clear/Stop key**
Press to cancel the copy number entered. While copying, press to stop copying. This key is also used to clear data.
7. **Number keys**
Use to enter the desired number of copies. They are also used to enter data.
8. **Lighter and Darker keys** See page 41.
9. **Auto Image Density key** See page 41.
10. **Auto Paper Select key** See page 42.

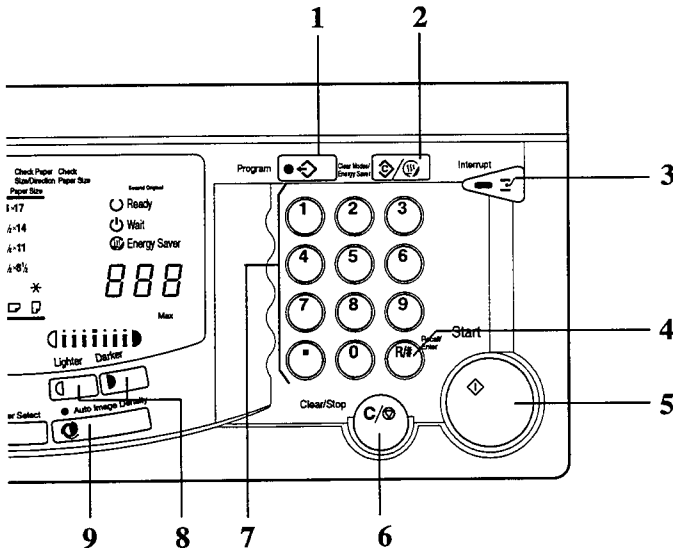

- | | |
|--|---|
| <p>11. Paper Selection key
☛ See page 40.</p> <p>12. Full Size key ☛ See page 40.</p> <p>13. Auto Reduce/Enlarge key
☛ See page 44.</p> <p>14. Enlarge key ☛ See page 49.</p> <p>15. Reduce key ☛ See page 49.</p> <p>16. Zoom Up key
Enlarges in 1% steps. ☛ See page 50.</p> <p>17. Zoom Down key
Reduces in 1% steps. ☛ See page 50.</p> | <p>18. Size Magnification key
Copier sets the magnification for your paper and original sizes. ☛ See page 51.</p> <p>19. Erase key ☛ See page 65.</p> <p>20. Cover/Slip Sheet key
☛ See pages 58 ~ 64.</p> <p>21. Single Copies key ☛ See pages 53 ~ 57.</p> <p>22. Duplex key
☛ See pages 70 ~ 73.</p> <p>23. Sorter key (option)
☛ See pages 74 ~ 79.</p> |
|--|---|

Indicators 2 With 1000-sheet Large Capacity Tray And Unit For Two-sided Copying

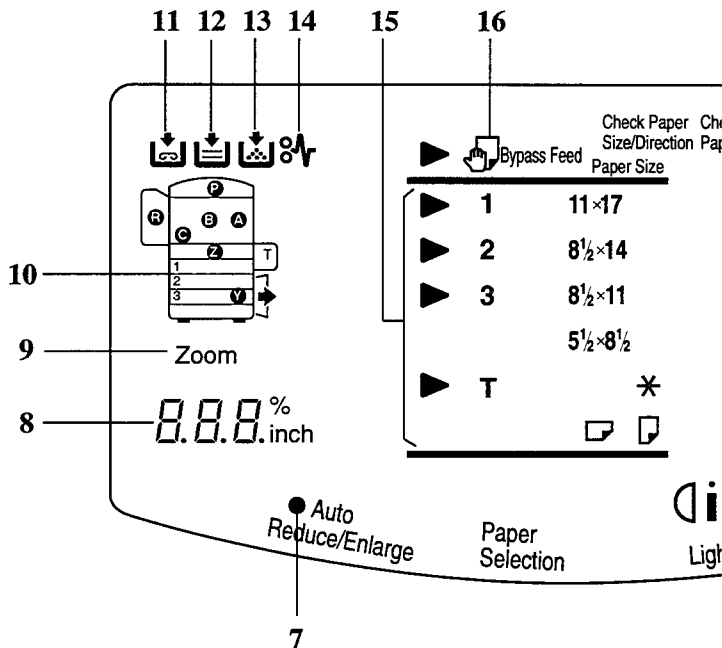

1. **Ready indicator** ☛ See page 38.
2. **Wait indicator** ☛ See page 38.
3. **Energy Saver indicator**
☛ See pages 39 and 81.
4. **Copy Counter**
Indicates the number of copies.
Data display. ☛ See pages 87 and 112.
5. **Max indicator** ☛ See page 89.
6. **Manual Image Density indicator**
☛ See pages 41 and 89.
7. **Auto Reduce/Enlarge indicator**
☛ See page 44.
8. **Three Digit indicator**
Data display.
9. **Zoom indicator**
Lights when you use the Zoom function.

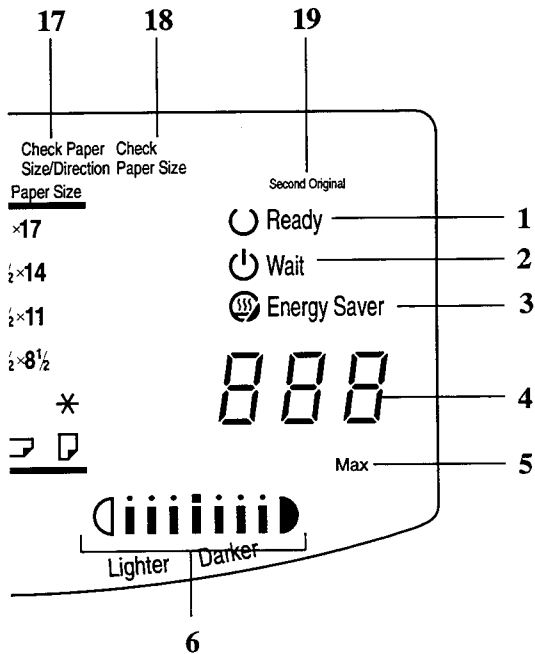

10. Misfeed Location display
 ☛ See page 96.

11. Add Staple indicator ☛ See pages 86 and 95.

12. Load Paper indicator
 ☛ See pages 86 and 91.

13. Add Toner indicator ☛ See pages 86 and 94.

14. Check Paper Path indicator
 ☛ See pages 86 and 96.

15. Paper Size indicators
 Show the selected feed station, copy paper size, and direction.

16. Bypass Feed indicator
 ☛ See page 46.

17. Check Paper Size/Direction indicator ☛ See page 89.

18. Check Paper Size indicator
 ☛ See page 88.

19. Second Original indicator
 ☛ See pages 89.

WHAT YOU CAN DO WITH THIS COPIER

WHAT YOU CAN DO WITH
THIS COPIER

FUNCTIONS

Auto image density

➡ See page 41.

Manual image density

➡ See page 41.

Having the copier choose the paper size

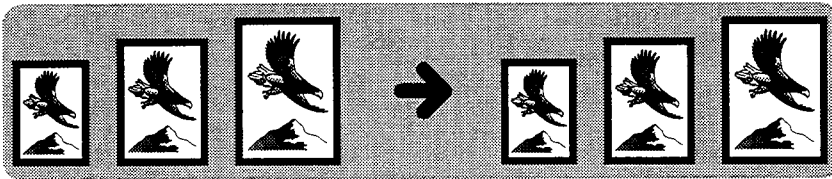

➡ See page 42.

Having the copier choose the reproduction ratios

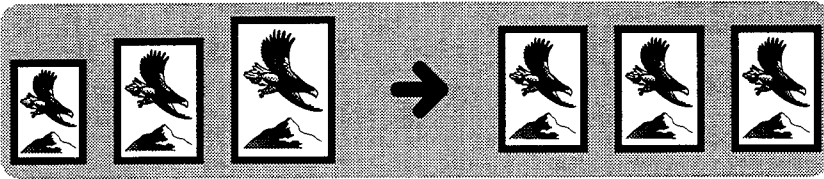

➡ See page 44.

Copying from the bypass feed table

➡ See page 45.

Temporarily stopping one job to copy something else

➡ See page 47.

Reducing and enlarging

Reducing and enlarging using preset ratios



Reducing and enlarging with the Zoom Up (+) and Zoom Down (-) keys



Fitting the original to a copy of a different size



➡ See page 49.

Entering copy job settings during the warm-up period

➡ See page 52.

WHAT YOU CAN DO WITH THIS COPIER

Making one-sided copies from various originals

From 2 one-sided originals to 1 one-sided copy

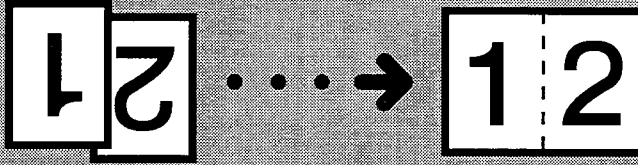

From 1 two-sided original to 2 one-sided copies

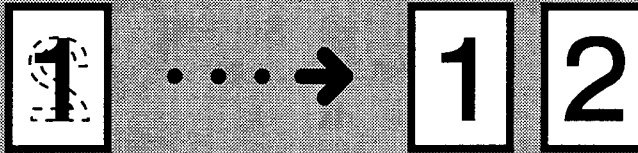

From 2 facing pages to 2 one-sided copies

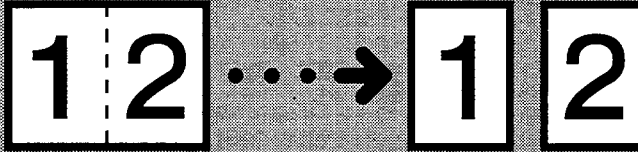

➡ See page 53.

Adding or inserting sheets

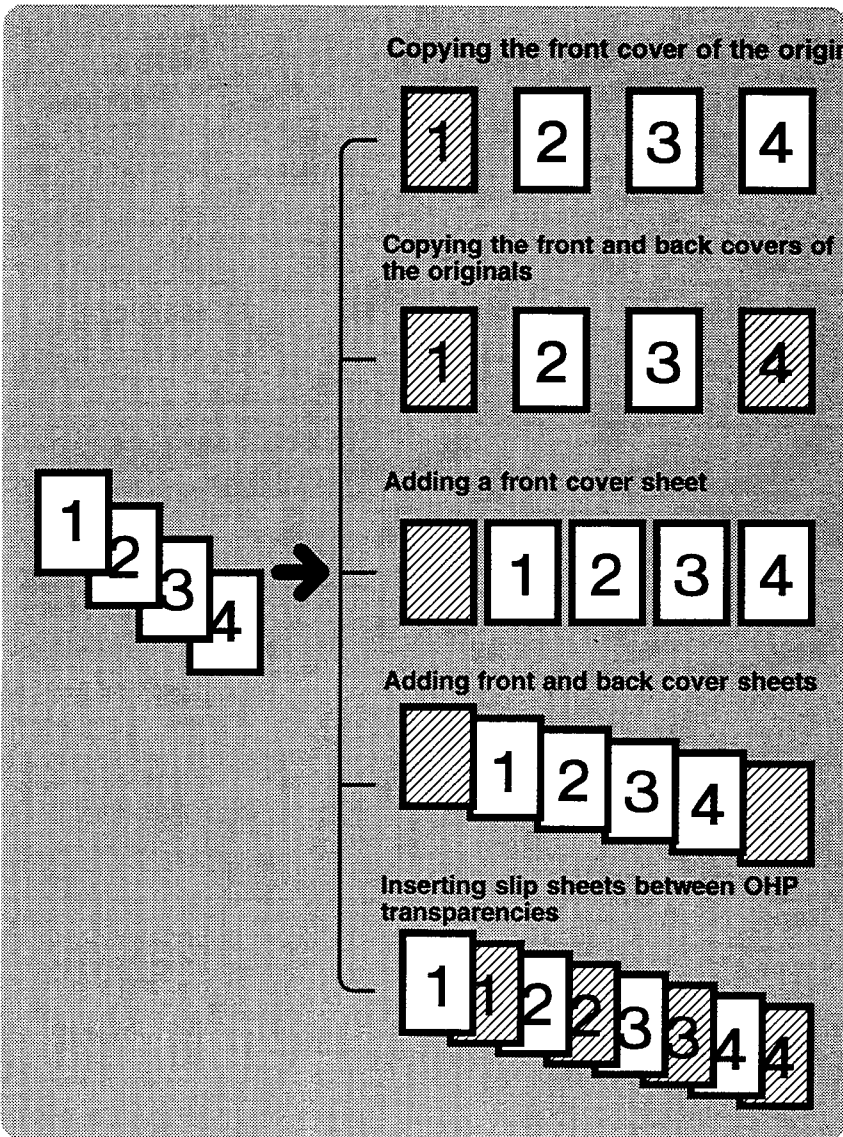

WHAT YOU CAN DO WITH THIS COPIER

☛ See page 58.

Erasing parts of copy image

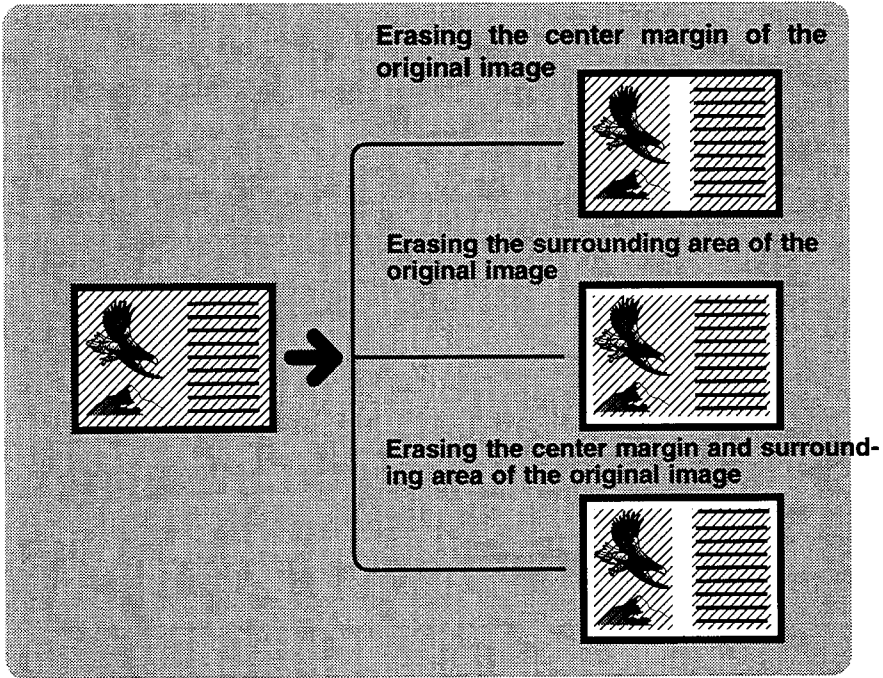

See page 65.

Storing your copy settings in memory

➡ See page 67.

Making two-sided copies

From an even number of one-sided originals

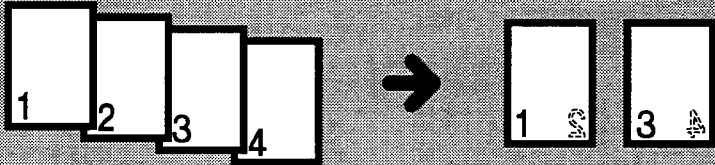

From an odd number of one-sided originals

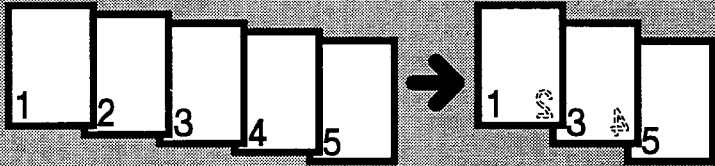

From two-sided originals

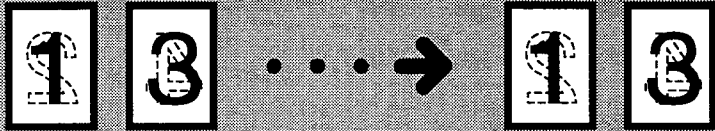

From facing pages

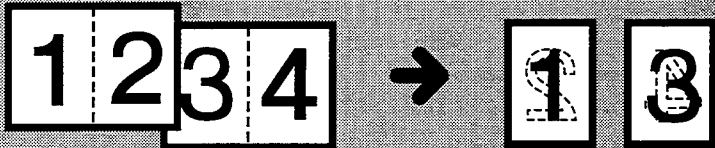

➡ See page 70.

WHAT YOU CAN DO WITH
THIS COPIER

Finishing

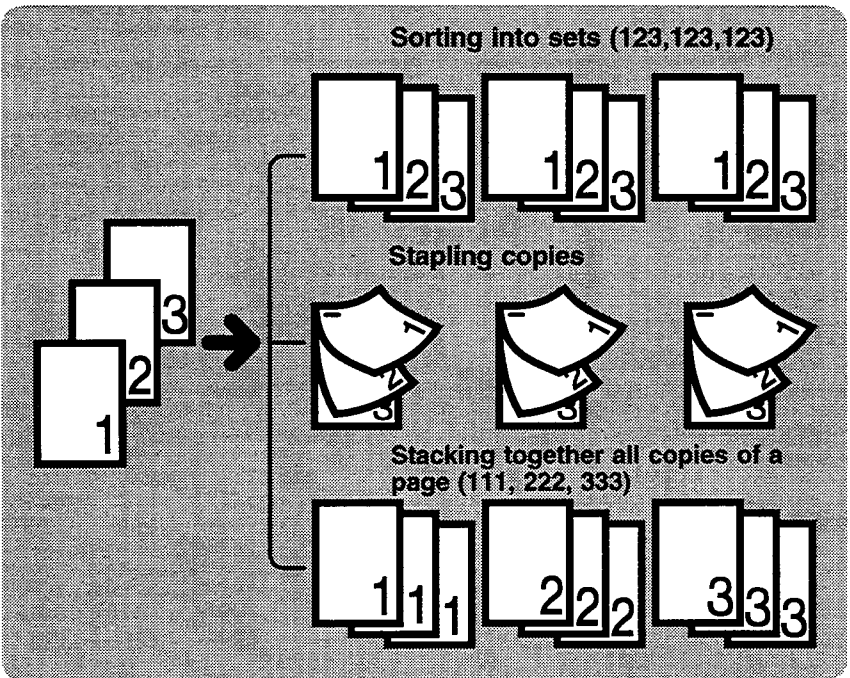

➡ See page 74.

HINTS

Example 1

You have to give a presentation of your company's new products to your clients tomorrow. Now, you have finished making the material but you still have to copy this material to OHP sheets and also make copies for your clients.

- For copying your material onto OHP sheets, you'll use the optional document feeder.
- For copying your material for your clients, you'll use the 10-bin sorter stapler option.

Copying your material onto OHP sheets

If you make copies following the procedure below, sheets will be inserted between OHP sheets to prevent friction between OHP sheets. This way, you can smoothly take and set your OHP sheets.

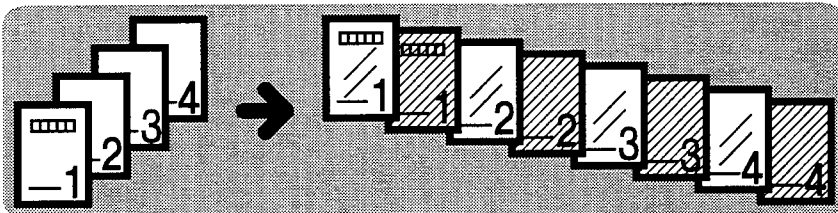

➤ **Inserting slip sheets between OHP transparencies**

➡ See page 63.

Copying and stapling your material for your clients

Make the required number of stapled copies.



➤ **Stapling copies** ➡ See page 75.

WHAT YOU CAN DO WITH THIS COPIER

Example 2

You are studying for an examination, but because you were absent from your classes for two days and you could not take notes, you have to ask your friend to lend you his notebook to make copies of it.

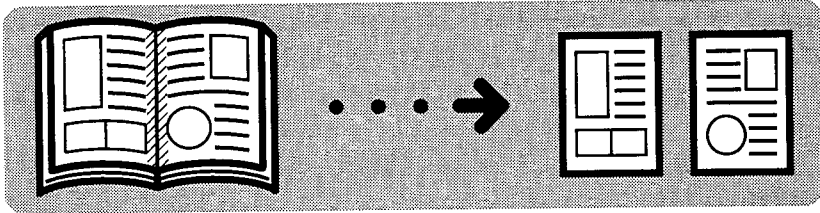

↪ **Making 2 one-sided copies from 2 facing pages**
☛ See page 56.

↪ **Erasing the surrounding area of the original image**
☛ See page 65.

Example 3

Every Monday, you distribute a report named "Weekly events at the head office" to local branches. Your report is always 27 pages. You want to make required number of 2-sided copies.

- Your copier has a large capacity tray and a unit for two-sided copying and a 20-bin sorter.

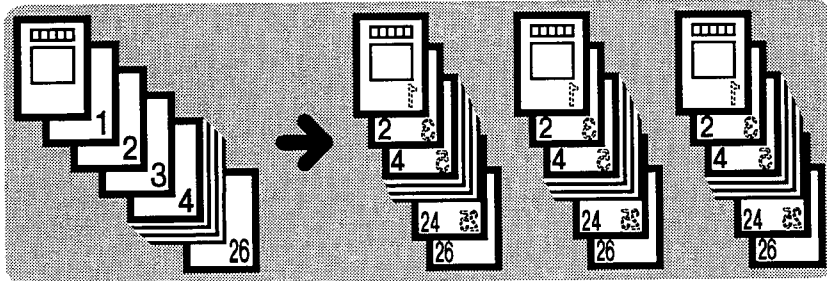

- ↪ **Making two sided copies from an odd number of one sided originals** ➤ See page 71.

- ↪ **Sorting into sets (123, 123, 123)** ➤ See page 74.

Because you make the same copies every Monday, we suggest that you store these settings in the copier's memory.

- ↪ **Storing your copy settings in memory** ➤ See page 67.

WHAT YOU CAN DO WITH THIS COPIER

SETTING ORIGINALS

SETTING ORIGINALS

Recommended Originals

- Regarding originals that the optional document feeder can handle, see page 149.

Non-recommended Originals For The Optional Document Feeder

Caution: The following types of originals are not recommended for use with the document feeder. Place them directly on the exposure glass.

- Originals thicker than 34 lb
- Originals thicker than 28 lb when using two-sided originals
- Originals thinner than 11 lb. But for originals between 11 and 14 lb, the document feeder must be set to Thin Original mode. See page 122.
- Originals larger than 11" x 17"
- Originals smaller than 5 1/2" x 8 1/2"
- Originals smaller than 5 1/2" x 8 1/2" sideways when you use Combine Originals See page 53.
- Paper with any kind of coating (such as carbon) on the back
- Folded, curled, creased, or damaged originals
- Mailing labels, or perforated originals
- Bound, stapled, or clipped originals
- OHP transparencies
- Translucent paper
- Pasted originals
- Damp originals
- Sticky originals
- Wavy originals
- Originals that are not made from paper
- Originals written in pencil on both sides, or two-sided carbon originals
- Thermal fax paper

SETTING ORIGINALS ON THE EXPOSURE GLASS

- 1** Lift the optional platen cover or the optional document feeder.

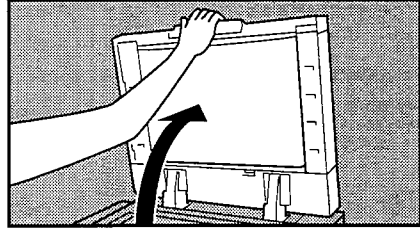

- 2** Set the original *face down* on the exposure glass. The original should be aligned to the rear left corner.

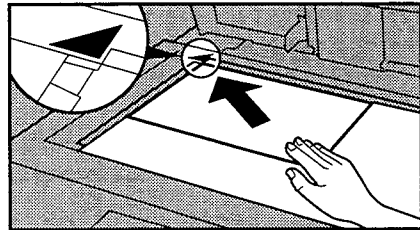

- 3** Lower the optional platen cover or the optional document feeder.

SETTING A STACK OF ORIGINALS IN THE OPTIONAL DOCUMENT FEEDER

You can insert a stack of originals (one-sided or two-sided) of the same size into the document feeder. These originals are individually fed onto and removed from the exposure glass.

- If you want to set originals of different sizes at the same time, use the user tools.
 ➔ See page 122.

1 Correct any curl, fold, or crease in the originals before setting.

2 Confirm that the **Insert Original** indicator is lit before setting the originals.

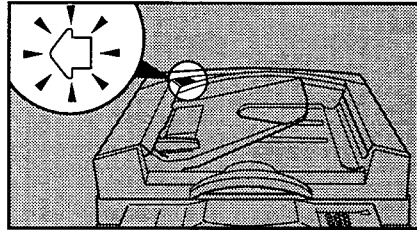

3 Confirm that no previous originals remain on the exposure glass.

4 Adjust the guide to the original size.

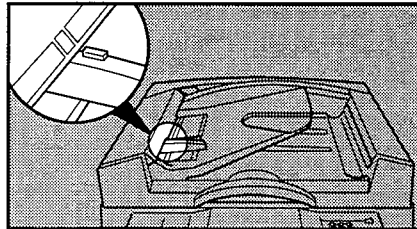

5 Set the originals *face up* into the document feeder until the **Insert Original** indicator goes off.

- The last page should be on the bottom.
- The guide must touch the front side of the originals.

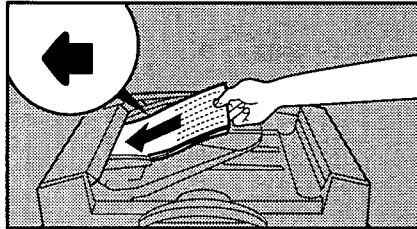

SETTING A STACK OF ORIGINALS IN THE OPTIONAL DOCUMENT FEEDER

- Do not stack originals above the limit mark.

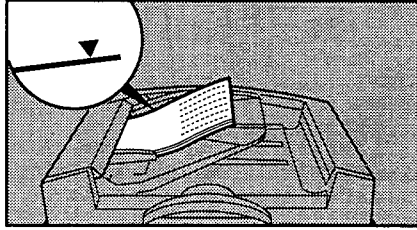

SETTING ONE ORIGINAL AT A TIME IN THE OPTIONAL DOCUMENT FEEDER

You can insert one original at a time into the document feeder. The original is automatically fed onto and removed from the exposure glass.

1 Correct any curl, fold, or crease in the originals before setting.

2 Confirm that the **Insert Original** indicator is lit before setting the originals.

3 Confirm that no previous originals remain on the exposure glass.

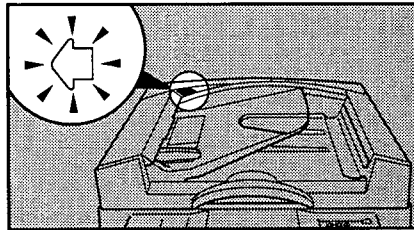

4 Adjust the guide to the original size.

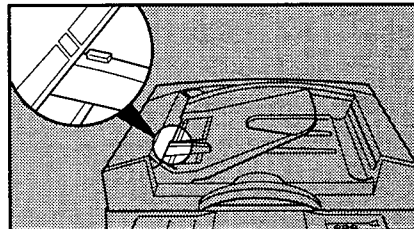

5 Set the original *face up* into the document feeder until the **Insert Original** indicator goes off.

- If you are copying a stack of originals one sheet at a time and you want to keep them in order, start with the last page of the originals.
- The original guide must touch the front side of the original.

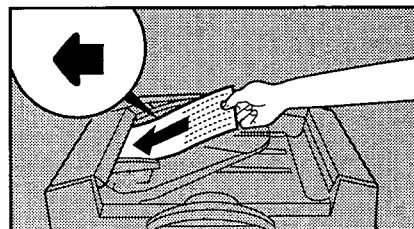

6 Press the **Start** key.

7 While the **Auto Feed** indicator is lit after an original is fed, set the next original. The original is automatically fed and copied.

- If you have set more than two originals, the **Auto Feed** indicator is not lit after the last original is fed. In this case, press the **Start** key again after setting an original.

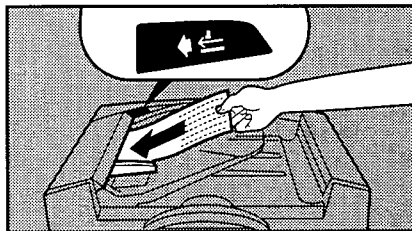

COPYING

COPYING

STARTING THE COPIER

When The Main Switch Is In The Stand-by Position

- 1** Turn on the main switch.

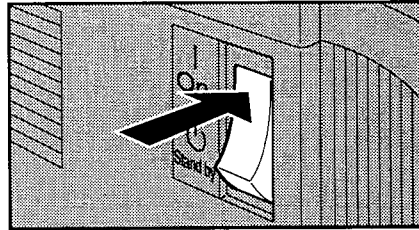

- 2** Wait for the copier to warm-up. During the warm-up period (less than 80 seconds), the  Wait indicator is on.

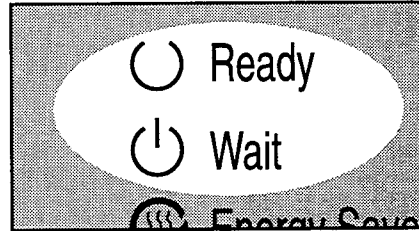



- 3** After the warm-up, the  Ready indicator lights.

When The Energy Saver Indicator Is On

The copier is in the Energy Saver or Auto Off mode.

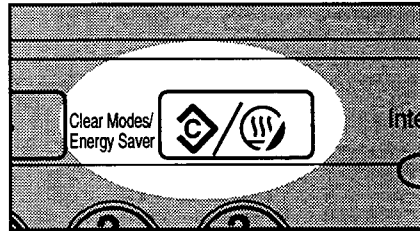

Press the **Clear Modes/Energy Saver** key to return to the ready condition.

- For details about Energy Saver,  see pages 81 and 118.
- For details about Auto Off,  see page 119.
- The following actions will also make the copier ready:
 - Opening or closing the platen cover.
 - Opening or closing the optional document feeder.
 - Setting originals in the optional document feeder.
 - Opening or closing the bypass feed table.
 - Setting copy paper in the bypass feed table.
 - Pressing any key except the **Start** key.



When The Copier Is Set For User Codes

Input your user code (3 digits) using the **Number** keys. Press the **Recall/Enter** key.

- To prevent others from making copies using your user code, press the **Clear/Stop** and **Clear Modes/Energy Saver** key simultaneously after copying.
- Regarding user codes,  see page 124.
- To set your copier for user codes, contact your service representative.  See page 132.

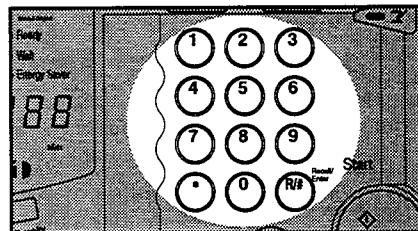

FREQUENTLY USED FUNCTIONS

One-to-one Copying

You can make copies that are the same size as your originals.

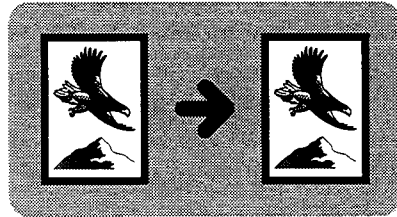

1 Set your original on the exposure glass or in the optional document feeder. ➔ See page 31, 32, or 34.

2 Enter the number of copies required using the **Number** keys.

- To change the number entered, press the **Clear/Stop** key, then enter the new number.

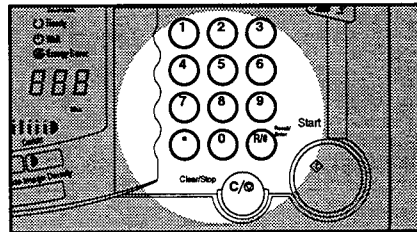

3 Confirm that the **Auto Paper Select** indicator is on. If not, press the **Auto Paper Select** key, or select the copy paper using the **Paper Selection** key.

- Regarding Auto Paper Select, ➔ see page 42.

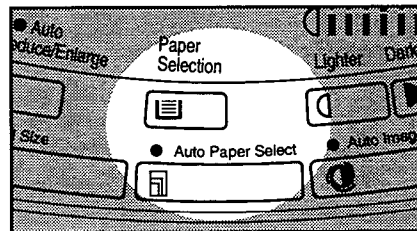

4 Make sure that the magnification ratio is set to 100%. If not, press the **Full Size** key.

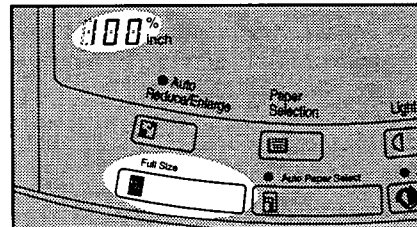

5 Press the **Start** key.

- To stop the copier during the multi-copy run, press the **Clear/Stop** key.
- Press the **Start** key to resume copying, or press the **Clear/Stop** key again to clear the entered copy number.

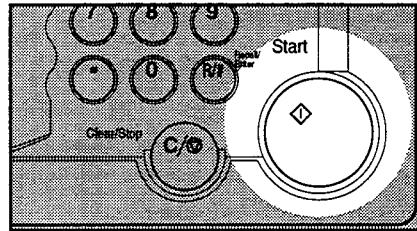

Adjusting Copy Image Density

To match the type of originals, adjust the image density.

Auto image density

If the **Auto Image Density** indicator is lit, the copier automatically controls the image density. If the indicator is not lit, press the **Auto Image Density** key.

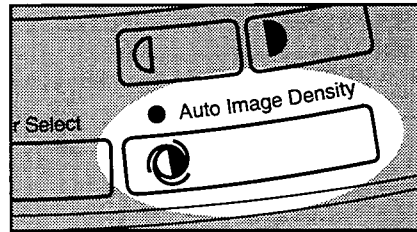

Manual image density

If you have dark or light originals, adjust the image density yourself.

Press the **Lighter** (left) key to lower the image density. Press the **Darker** (right) key to increase the image density.

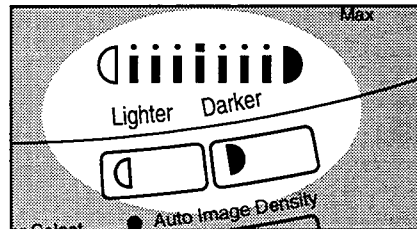

COPYING

Having The Copier Choose The Paper Size (Auto Paper Select)

The copier selects a suitable size of copy paper based on the original size and the reproduction ratio.

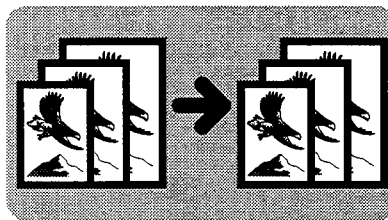

- If you use translucent or transparent originals or originals with tags, the original size might not be detected correctly.
- When placing the original on the exposure glass directly, make sure that the optional platen cover or optional document feeder is lowered before pressing the **Start** key. If not, the original size might not be detected correctly.
- Regarding functions that cannot be used together with this function, see page 82.

Example 1: When making full size copies

- 1** Make sure that the **Auto Paper Select** indicator is lit. If not, press the **Auto Paper Select** key.

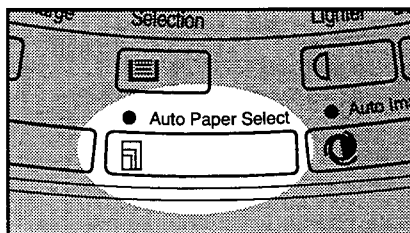

- 2** Make sure that the magnification ratio is set to 100%. If not, press the **Full Size** key.

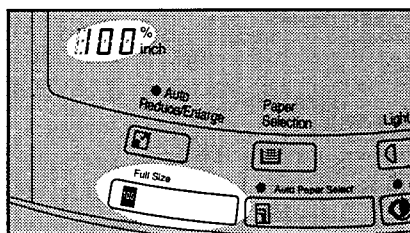

- 3** Set your original on the exposure glass or in the optional document feeder. See page 31, 32 or 34.

- 4** Press the **Start** key.
The copier selects paper of the same format and orientation as the original.

Example 2: When making reduced copies

Example: Original: 11" x 17" lengthwise
 Reproduction ratio: 65%

- 1 Make sure that the **Auto Paper Select** indicator is lit. If not, press the **Auto Paper Select** key.

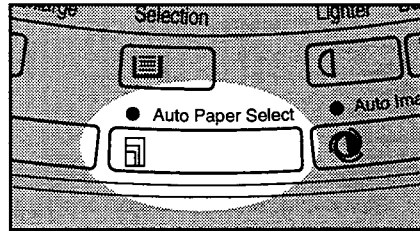

- 2 Select 65% using the **Reduce** key.

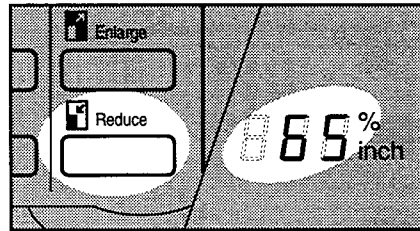

- 3 Set your original on the exposure glass or in the optional document feeder. ➔ See page 31, 32, or 34.

- 4 Press the **Start** key.

8 1/2" x 11" lengthwise copy paper will be selected.

Having The Copier Choose The Reproduction Ratios (Auto Reduce/Enlarge)

The copier can select the proper reproduction ratio based on the selected paper size and the original size.

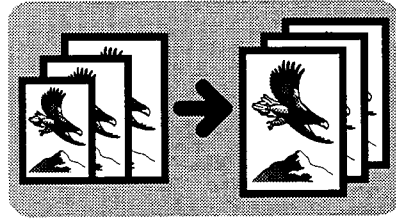

- If you use translucent or transparent originals or originals with tags, the original size might not be detected correctly.
- When placing the original on the exposure glass directly, make sure that the optional platen cover or optional document feeder is lowered before pressing the **Start** key. If not, the original size might not be detected correctly.
- Regarding functions that cannot be used together with this function, see page 82.

Example: Original size: 11" x 17" lengthwise
 Copy paper size: 8 1/2" x 11" lengthwise

1 Press the **Auto/Reduce Enlarge** key.

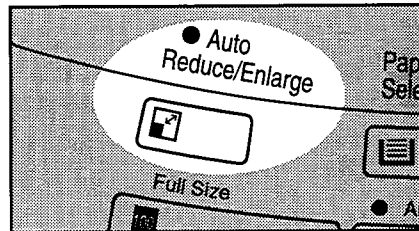

2 Set your original on the exposure glass or in the optional document feeder. See page 31, 32, or 34.

3 Select the copy paper using the **Paper Selection** key.

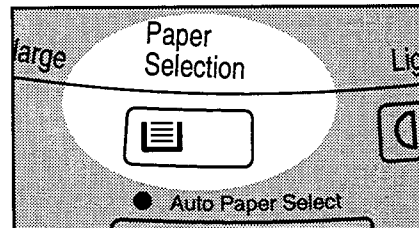

4 Press the **Start** key. 65% will be selected.

Copying From The Bypass Feed Table

Use the bypass feed table to copy onto OHP transparencies, adhesive labels, translucent paper, and post cards.

- Adhesive labels should be fed from the bypass feed table one sheet at a time.
- OHP transparencies should be fed from the bypass feed table. You can set ten sheets at a time. However, if misfeed or multi-feed occurs, set sheets one at a time.
- OHP transparencies should be fanned to get air between the sheets before loading.
- Translucent paper should be fed from the bypass feed table.
- Translucent paper should be fed so that the paper grain is oriented with the paper path.
- Postcards should be fed from the bypass feed table. Correct any curls they might have before loading them.
- It is recommended to feed one post card at a time.
- When you use the bypass feed table while placing the original directly on the exposure glass, lower the platen cover or optional document feeder before pressing the **Start** key.
- Regarding functions that cannot be used together with this function, see page 82.

1 Set your original on the exposure glass or in the optional document feeder. See page 31, 32, or 34.

2 Open the bypass feed table.

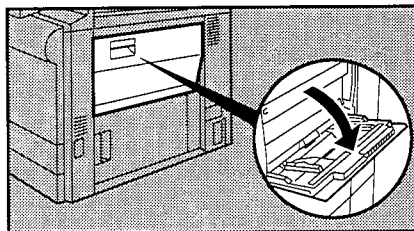

FREQUENTLY USED FUNCTIONS

- 3** Make sure that the  **Bypass Feed** indicator is lit. If it is not lit, press the **Paper Selection** key to select the bypass feed table.

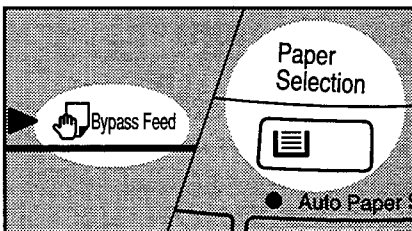

- 4** Slide the paper guides to the paper width and, if necessary, swing out the extender to support large size copy paper.

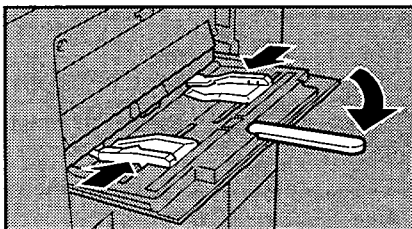

- 5** Insert the copy paper into the bypass feed table.

- Approximately 40 sheets of copy paper (20 lb) can be inserted at a time.
- Do not insert copy paper after the **Load Paper**  indicator turns off.

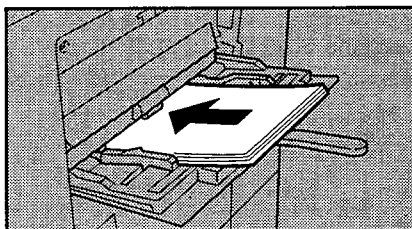

- 6** Press the **Start** key.